

# Skewed Steel Bridges: Effect of Cross-Frame Layout on Lateral Flange Bending Stresses

James Zhou  
Caroline Bennett, Ph.D., P.E.  
Adolfo Matamoros, Ph.D., P.E.  
Jian Li, Ph.D.  
Stan Rolfe, Ph.D., P.E.

*The University of Kansas*

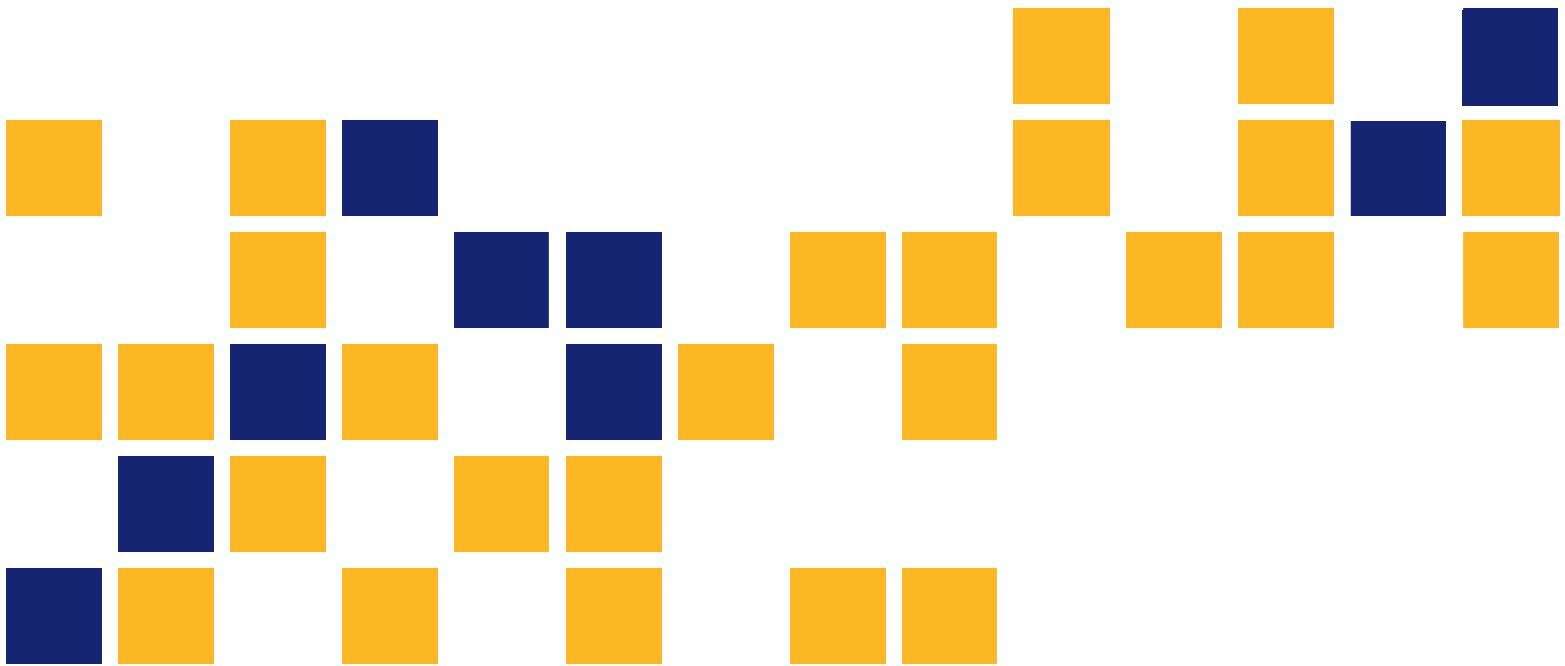



<b>1 Report No.</b> K-TRAN: KU-13-3	<b>2 Government Accession No.</b>	<b>3 Recipient Catalog No.</b>	
<b>4 Title and Subtitle</b> Skewed Steel Bridges: Effect of Cross-Frame Layout on Lateral Flange Bending Stresses		<b>5 Report Date</b> February 2016	<b>6 Performing Organization Code</b>
		<b>7 Performing Organization Report No.</b>	
<b>7 Author(s)</b> James Zhou, Caroline Bennett, Ph.D., P.E., Adolfo Matamoros, Ph.D., P.E., Jian Li, Ph.D., Stan Rolfe, Ph.D., P.E.		<b>10 Work Unit No. (TRAIS)</b>	
<b>9 Performing Organization Name and Address</b> The University of Kansas Department of Civil, Environmental and Architectural Engineering 1530 West 15th St Lawrence, Kansas 66045-7609		<b>11 Contract or Grant No.</b> C1934	
		<b>13 Type of Report and Period Covered</b> Final Report July 2012–June 2015	
<b>12 Sponsoring Agency Name and Address</b> Kansas Department of Transportation Bureau of Research 2300 SW Van Buren Topeka, Kansas 66611-1195		<b>14 Sponsoring Agency Code</b> RE-0602-01	
		<b>15 Supplementary Notes</b> For more information write to address in block 9.	
<p>Lateral flange bending stresses can arise from a number of sources, such as wind loading or eccentric concrete placement, but of particular interest are lateral flange bending stresses, <math>f_l</math>, that occur due to skew. Lateral flange bending stresses that occur in skewed bridge systems tend to develop due to lateral forces transferred through cross frames which may connect adjacent girders at different span points. In lieu of a refined analysis, the AASHTO (2010) <i>LRFD Bridge Design Specifications</i> currently permit engineers examining bridges skewed more than 20° to use a minimum value of <math>f_l = 10</math> ksi for an interior girder and <math>f_l = 7.5</math> ksi for an exterior girder. The estimates for <math>f_l</math> provided within the <i>AASHTO LRFD Bridge Design Specifications</i> are based on a limited data set for skewed bridges. Additionally, since the <i>AASHTO LRFD Bridge Design Specifications</i> state that cross frames or diaphragms should be placed in a staggered configuration when a bridge is skewed more than 20°, the approximate values provided for <math>f_l</math> should not be expected to be indicative of the lateral flange bending stresses experienced when cross frames are instead carried parallel to the skew in bridges skewed beyond 20°.</p> <p>The authors have performed a study to investigate the effects of cross frame orientation and skew angle upon lateral flange bending stresses, by examining lateral flange bending stresses in a suite of detailed 3D solid finite element analyses of skewed bridge systems, in which cross frame layout, spacing, and skew angle were varied. The findings of this study showed that cross frames placed parallel to the angle of skew produced significantly lower values for <math>f_l</math> than cases in which cross frames were placed perpendicular to the girder line and staggered. Both reducing the skew angle and decreasing cross frame spacing were found to reduce lateral flange bending stresses. The values of lateral flange bending stress for all configurations were greater than the bounds of the approximate values suggested by AASHTO.</p>			
<b>17 Key Words</b> Skewed Steel Bridges, Lateral Flange Bending Stresses, Cross Frames		<b>18 Distribution Statement</b> No restrictions. This document is available to the public through the National Technical Information Service <a href="http://www.ntis.gov">www.ntis.gov</a> .	
<b>19 Security Classification (of this report)</b> Unclassified	<b>20 Security Classification (of this page)</b> Unclassified	<b>21 No. of pages</b> 31	<b>22 Price</b>

This page intentionally left blank.

# **Skewed Steel Bridges: Effect of Cross-Frame Layout on Lateral Flange Bending Stresses**

Final Report

Prepared by

James Zhou  
Caroline Bennett, Ph.D., P.E.  
Adolfo Matamoros, Ph.D., P.E.  
Jian Li, Ph.D.  
Stan Rolfe, Ph.D., P.E.

The University of Kansas

A Report on Research Sponsored by

THE KANSAS DEPARTMENT OF TRANSPORTATION  
TOPEKA, KANSAS

and

THE UNIVERSITY OF KANSAS  
LAWRENCE, KANSAS

February 2016

© Copyright 2016, **Kansas Department of Transportation**

## **PREFACE**

The Kansas Department of Transportation's (KDOT) Kansas Transportation Research and New-Developments (K-TRAN) Research Program funded this research project. It is an ongoing, cooperative and comprehensive research program addressing transportation needs of the state of Kansas utilizing academic and research resources from KDOT, Kansas State University and the University of Kansas. Transportation professionals in KDOT and the universities jointly develop the projects included in the research program.

## **NOTICE**

The authors and the state of Kansas do not endorse products or manufacturers. Trade and manufacturers names appear herein solely because they are considered essential to the object of this report.

This information is available in alternative accessible formats. To obtain an alternative format, contact the Office of Public Affairs, Kansas Department of Transportation, 700 SW Harrison, 2<sup>nd</sup> Floor – West Wing, Topeka, Kansas 66603-3745 or phone (785) 296-3585 (Voice) (TDD).

## **DISCLAIMER**

The contents of this report reflect the views of the authors who are responsible for the facts and accuracy of the data presented herein. The contents do not necessarily reflect the views or the policies of the state of Kansas. This report does not constitute a standard, specification or regulation.

## Abstract

Lateral flange bending stresses can arise from a number of sources, such as wind loading or eccentric concrete placement, but of particular interest are lateral flange bending stresses,  $f_l$ , that occur due to skew. Lateral flange bending stresses that occur in skewed bridge systems tend to develop due to lateral forces transferred through cross frames which may connect adjacent girders at different span points. In lieu of a refined analysis, the AASHTO (2010) *LRFD Bridge Design Specifications* currently permit engineers examining bridges skewed more than  $20^\circ$  to use a minimum value of  $f_l = 10$  ksi for an interior girder and  $f_l = 7.5$  ksi for an exterior girder. The estimates for  $f_l$  provided within the *AASHTO LRFD Bridge Design Specifications* are based on a limited data set for skewed bridges. Additionally, since the *AASHTO LRFD Bridge Design Specifications* state that cross frames or diaphragms should be placed in a staggered configuration when a bridge is skewed more than  $20^\circ$ , the approximate values provided for  $f_l$  should not be expected to be indicative of the lateral flange bending stresses experienced when cross frames are instead carried parallel to the skew in bridges skewed beyond  $20^\circ$ .

The authors have performed a study to investigate the effects of cross frame orientation and skew angle upon lateral flange bending stresses, by examining lateral flange bending stresses in a suite of detailed 3D solid finite element analyses of skewed bridge systems, in which cross frame layout, spacing, and skew angle were varied. The findings of this study showed that cross frames placed parallel to the angle of skew produced significantly lower values for  $f_l$  than cases in which cross frames were placed perpendicular to the girder line and staggered. Both reducing the skew angle and decreasing cross frame spacing were found to reduce lateral flange bending stresses. The values of lateral flange bending stress for all configurations were greater than the bounds of the approximate values suggested by AASHTO.

## **Acknowledgements**

The authors of this report would like to gratefully acknowledge the Kansas Department of Transportation for its support of the work performed under this project, and for knowledgeable guidance and input provided by Mr. John Jones throughout the project activities.



# Table of Contents

Abstract .....	v
Acknowledgements .....	vi
Table of Contents .....	vii
List of Tables .....	viii
List of Figures .....	viii
Introduction and Background .....	1
Bridge Geometry .....	1
Modeling Methodology .....	4
Applied Loads .....	8
Stress Calculations .....	9
Results .....	12
Conclusions .....	19
References .....	20

## List of Tables

Table 1: Steel Stress-Strain Diagram.....	6
Table 2: AASHTO Interaction Equation Results for 40 Degree Skewed-Staggered with 4.6-m (15-ft) Cross Frame Spacing.....	14
Table 3: AASHTO Interaction Equation Results for 40 Degree Skewed-Parallel with 4.6-m (15-ft) Cross Frame Spacing.....	15
Table 4: AASHTO Interaction Equation Results for 40 Degree Skewed-Staggered with 9.1-m (30-ft) Cross Frame Spacing.....	16
Table 5: AASHTO Interaction Equation Results for 20 Degree Skewed-Staggered with 4.6-m (15-ft) Cross Frame Spacing.....	17
Table 6: AASHTO Interaction Equation Results for 20 Degree Skewed-Parallel with 4.6-m (15-ft) Cross Frame Spacing.....	18

## List of Figures

Figure 1: (a) Positive Girder Cross Section; (b) Negative Girder Cross Section; (c) Location of Positive and Negative Cross Sections .....	2
Figure 2: Bridge Configurations (40 Degree Skew with 4.57-m [15.0-ft] Cross Frame Spacing) .....	3
Figure 3: Connection Stiffener Geometry.....	4
Figure 4: 3D FE Model Geometry of Skewed-Staggered Bridge Configuration .....	5
Figure 5: Steel Stress-Strain Diagram.....	6
Figure 6: Resultant Moments Displayed on the Free Body Section.....	10
Figure 7: Deformed Shape of the 40 Degree Skewed-Parallel with 4.57-m (15.0-ft) Cross Frame Spacing .....	13

## Introduction and Background

The American Association of State Highway and Transportation Officials (AASHTO) provisions for lateral flange bending stresses are based on the assumption that cross frames are oriented perpendicular to the girder line whenever the skew angle is greater than 20 degrees (AASHTO, 2010). Current Kansas Department of Transportation (KDOT) design practice is to align cross frames parallel to the skew angle to avoid problems associated with fit-up and distortion-induced fatigue. There is a potentially significant discrepancy between assumptions implicit in the AASHTO (2010) Specifications and bridges that are designed to be skewed between 20 and 40 degrees that include cross frames placed parallel to the skew.

The objectives of this study were to quantify the effects of cross frame orientation and cross frame spacing on lateral flange bending stresses during the bridge construction phase and to evaluate AASHTO's interaction requirement of weak-axis bending demands with strong-axis demands on the flanges. Stability is especially of concern during construction stages, before a composite concrete deck has hardened; in this stage, steel girders rely on intermediate cross frames for stability. Detailed three-dimensional solid finite element (FE) models were used to investigate these parameters (skew angle, cross frame spacing, and cross frame orientation).

## Bridge Geometry

The bridge geometry used within this study was adapted from Design Example 2 in *Four LRF Design Examples of Steel Highway Bridges* (HDR Engineering, Inc., 1999). This geometry can be considered typical of a multi-girder highway overpass and its design is well understood and widely available. The bridge has two 27.4-m (90-ft) spans, composed of four continuous girders spaced at 3.1 m (10 ft), as presented in Figure 1. Girders were non-composite, topped by a 203-mm (8.0-in.) thick wet concrete deck with a 1.1-m (3.5-ft) roadway overhang and a 0.7-m (2.3-ft) construction walkway. The total deck width was 12.7 m (41.7 ft). Both the roadway overhang and construction walkway were supported by 1.8-m (70-in.) C-49-D overhang brackets spaced 1.0 m (40 in.) on center. Separate built-up cross sections were used in regions of

positive and negative bending, as shown in Figure 1(a) and 1(b). Each girder was supported by a pin at the central pier and roller supports at both ends.

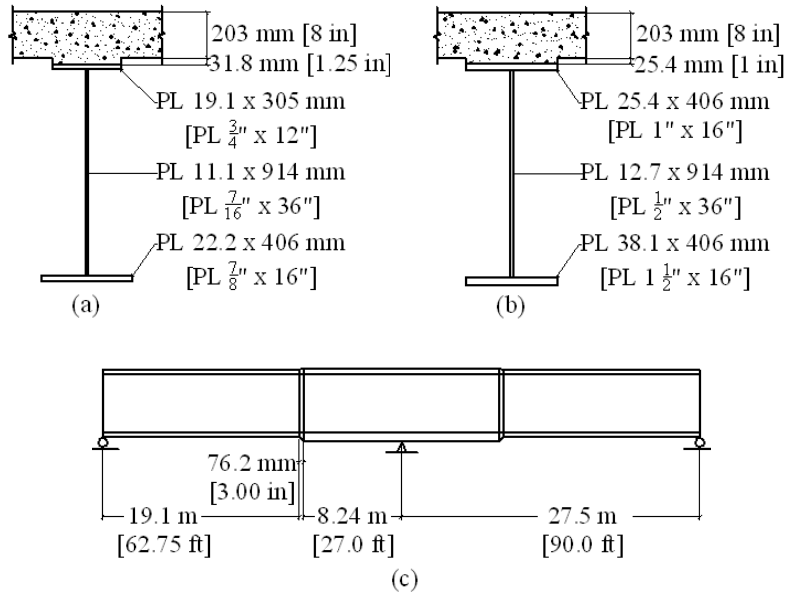

**Figure 1: (a) Positive Girder Cross Section; (b) Negative Girder Cross Section; (c) Location of Positive and Negative Cross Sections**

Bridges with skewed supports are designed as such to accommodate highway alignment. Three primary bracing configurations are used in skewed steel bridges. Bracing may be placed parallel to the skew angle, or perpendicular to the girder line in a staggered or unstaggered configuration. These configurations, shown in Figure 2, will be referred to as skewed-parallel, skewed-staggered, and skewed-unstaggered, respectively. AASHTO (2010) requires that bracing be placed perpendicular to the girder line whenever the skew angle is greater than 20 degrees. However, KDOT (2010) design provisions allow the use of skewed-parallel configuration for angles up to 40 degrees to reduce potential differential deflection and associated distortion-induced fatigue. For the analyses performed in this study, results for the skewed-parallel and skewed-staggered configurations with 20 degree and 40 degree skews were considered. Both 4.6-m (15-ft) and 9.1-m (30-ft) cross frame spacings were studied.

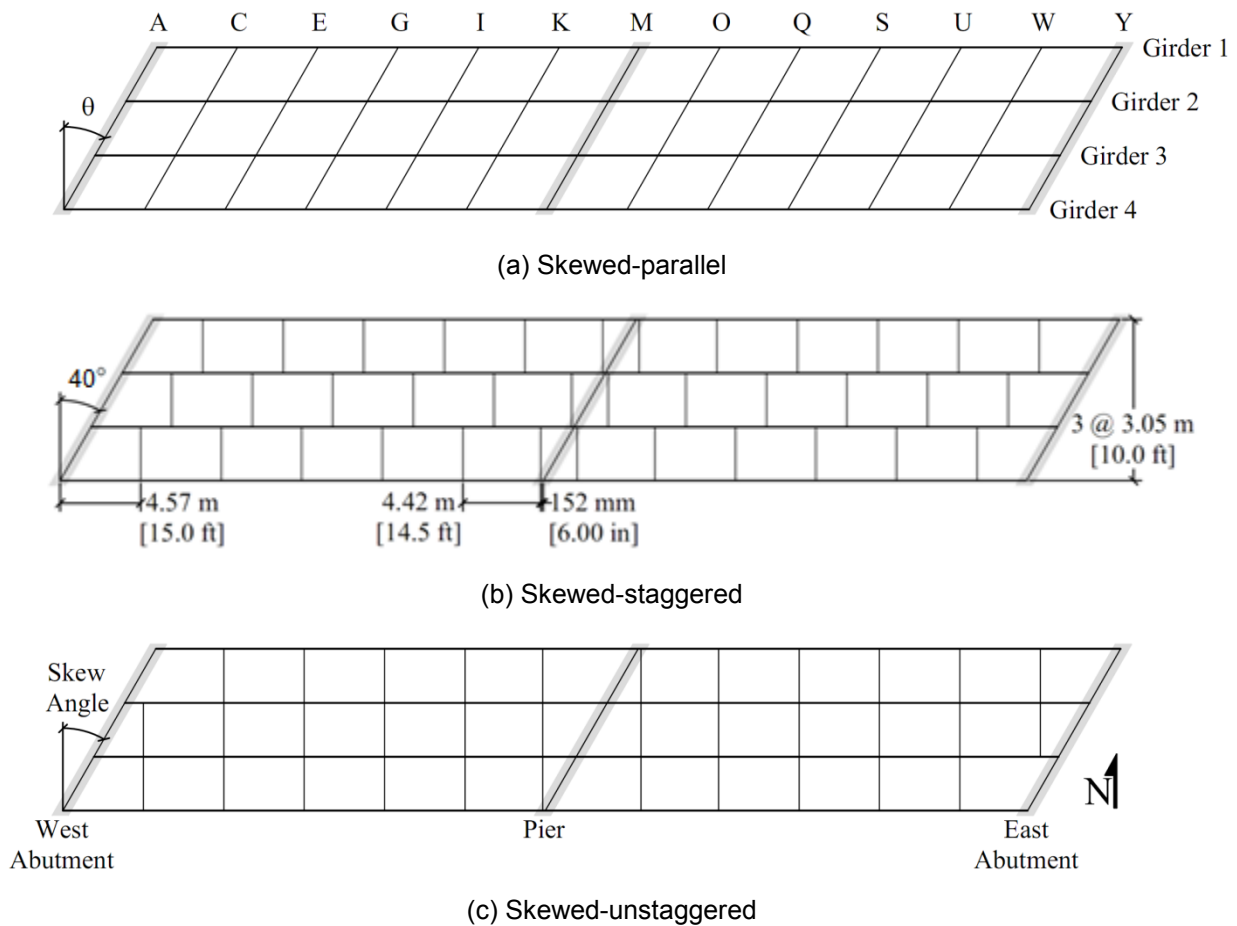

**Figure 2: Bridge Configurations (40 Degree Skew with 4.57-m [15.0-ft] Cross Frame Spacing)**

Cross frames, referring to truss-type lateral braces placed at discrete locations along a bridge layout, were used in all bridge configurations studied and consisted of three equal-leg angle cross sections spanning between connection stiffeners. A square plate was used to connect the diagonal legs, as shown in Figure 3. In bridges with skewed-parallel configurations, cross frame length increased with skew angle and bent plate stiffeners were used to capture realistic construction considerations. The slenderness ratio for the single angles was computed using provisions in the American Institute of Steel Construction's (AISC, 2010) *Steel Construction Manual* Section E5, and cross frame stiffness was compared based on the approximate relative stiffness,  $A \cos^3 \theta$ , where  $A$  is the cross-sectional area of one angle and  $\theta$  is the skew angle (Yura,

2001; Wang & Helwig, 2008). This was done to ensure that cross frames were selected in the different models such that they had similar stiffnesses. A L108 × 108 × 12.7-mm (L4.25 × 4.25 × 0.5-in.) angle was selected for the skewed-staggered bridge and a L140 × 140 × 15.9-mm (5.5 × 5.5 × 0.625-in.) angle was selected for the skewed-parallel bridge. Connection stiffener dimensions are shown in Figure 3; a thickness of 9.53 mm (0.375 in.) was selected for the skewed bridge connection stiffeners.

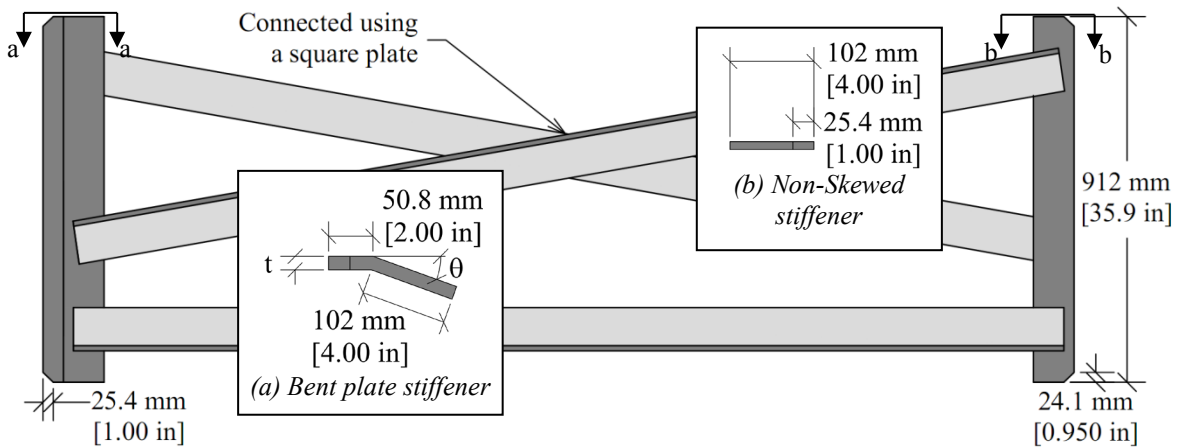

**Figure 3: Connection Stiffener Geometry**

## Modeling Methodology

Three-dimensional solid-element FE models of the entire bridge were constructed using Abaqus v.6.10-2 for parametric analysis, represented in Figure 4 (Abaqus FEA, 2010). C3D8R brick elements were used for the majority of the model, but C3D4 tetrahedral and C3D6 wedge elements were used to transition between mesh sizes where needed. Both geometric nonlinearity and material nonlinearity were considered within the analyses.



**Figure 4: 3D FE Model Geometry of Skewed-Staggered Bridge Configuration**

Each of the four bridge girders were composed of the bottom flange, web, and top flange. Girder flanges and webs were composed of steel with a modulus of elasticity of 200,000 MPa (29,000 ksi) and Poisson's ratio of 0.3. The steel was defined to undergo material nonlinearity through isotropic hardening. The material plasticity data defined within Abaqus are presented in Table 1 as true stress and logarithmic plastic strain; the piecewise-linear stress-strain curve is presented in Figure 5. A maximum mesh size of 51 mm (2 in.) was used for all steel parts.

**Table 1: Steel Stress-Strain Diagram**

True Stress (MPa) [ksi]	Logarithmic Plastic Strain
376.9 [54.7]	0
381.5 [55.3]	0.037
401.2 [58.2]	0.044
445.9 [64.7]	0.097
451.9 [65.5]	0.110
462.0 [67.0]	0.178

**Stress-Strain Diagram for Steel Material Used in the FE Models**

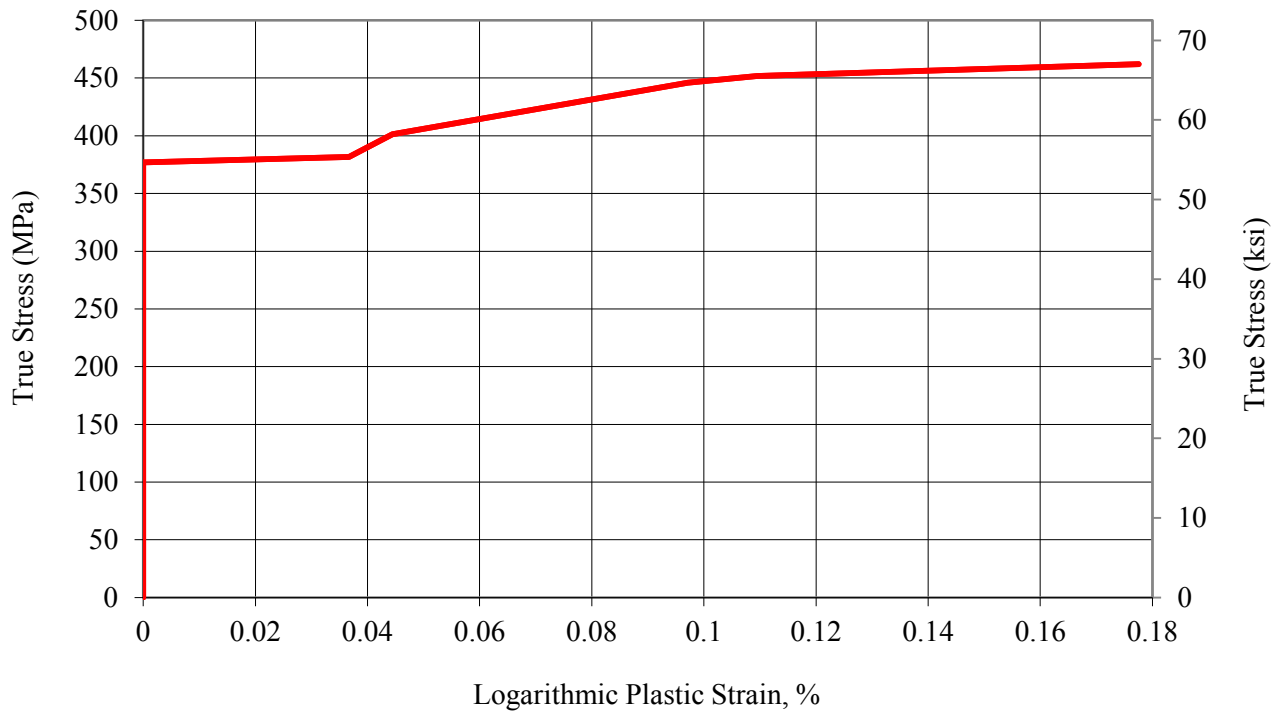

**Figure 5: Steel Stress-Strain Diagram**



The steel overhang brackets were modeled with the same properties as the girders. Five  $51 \times 51$ -mm ( $2 \times 2$ -in.) wall stud joists (timber) supporting the construction walkway and a  $102 \times 102$ -mm ( $4 \times 4$ -in.) stud (timber) supporting the screed rail on each side of the bridge were modeled with a modulus of elasticity of 10,342 MPa (1,500 ksi) and Poisson's ratio of 0.2. Plywood formwork supporting the wet concrete deck, typically used during construction, was not included in the models because the stiffness contribution from the attached plywood was found to affect lateral bending stresses significantly within the models, and since real connections between plywood formwork and steel girders are not capable of developing sufficient lateral support, designers rightfully neglect the contributions of such formwork.

Given the nonlinear characteristics of the models, it was not surprising that challenges with convergence were initially encountered and high-order buckling modes occurred as a modeling artifact. To eliminate the high-order buckling mode that tended to occur in girder flanges in trial model executions, a very thin and flexible top flange cover, with the same width as the top flange, was used to damp the response in the top flange. This "soft layer" was assigned a thickness of 25 mm (1 in.) in the positive moment region and 13 mm (0.5 in.) in the negative moment region to accommodate the difference in thickness of the top flange in these two regions. The flange cover had a modulus of elasticity of 2,760 MPa (400 ksi). Due to its low stiffness, use of this model control technique did not affect the bending moment results, and this was verified through a comparison of models that included/did not include the compliant layer on the flange.

Surface-to-surface ties were used to attach parts. Welds were explicitly modeled to connect the flanges, webs, and cross frame stiffeners. A mesh size of 4 mm (0.1 in.) was used for welds to maintain a reasonable element aspect ratio. Welds were modeled with the same material properties as other steel parts. Interactions between the connection stiffeners and girder flanges were defined using a hard contact definition. This allowed for the connection stiffener to bear against the girder flanges when flange rotations were significant. Girder boundary conditions were modeled by applying a translational constraint over a narrow 51-mm (2-in.) strip of the bottom flange at the mid-span and ends of the girders. A pinned support was used to represent the center pier while roller supports represented abutment piers.

## Applied Loads

The following dead and live loads applied in the models during the construction stage were based on the KDOT (2010) *Design Manual: Volume III*, Section 5.3. Wind pressures on the structure were based on AASHTO (2010) Section 3.8.

- The 203-mm (8-in.) thick wet concrete deck with a density of  $2,563 \text{ kg/m}^3$  ( $160 \text{ lb/ft}^3$ ) was applied as a uniform pressure over the vertical projection of the web on the top flange cover and roadway overhang. The density included the weight of reinforcing steel and forms.
- A 27.2-mm (1.07-in.) effective height of the concrete deck haunches was applied as a uniform pressure using a  $2,563\text{-kg/m}^3$  ( $160\text{-lb/ft}^3$ ) density over the vertical projection of the web on the top flange cover. This density included the weight of reinforcing steel and forms.
- Steel weight was applied as a gravity load using a density of  $7,849 \text{ kg/m}^3$  ( $490 \text{ lb/ft}^3$ ).
- A  $366\text{-kg/m}^2$  ( $75.0\text{-lb/ft}^2$ ) construction live load was applied as a uniform pressure over the vertical projection of the web on the top flange cover.
- A  $744\text{-kg/m}$  ( $500\text{-lb/ft}$ ) screed load was applied as a uniform pressure over a width of 102 mm (4.0 in.) on the plywood screed rail.
- A  $801\text{-kg/m}^3$  ( $50.0\text{-lb/ft}^3$ ) walkway load was applied as a uniform pressure over the construction walkway surface.
- A  $244\text{-kg/m}^2$  ( $50.0\text{-lb/ft}^2$ ) traverse wind load was applied over the lateral surface area of the deck exterior on either the south side in Figure 2 (right side in Figure 4) or north side in Figure 2 (left side in Figure 4). A longitudinal wind pressure was not considered.
- A vertical upward wind force of  $97.6 \text{ kg/m}^2$  ( $20 \text{ lb/ft}^2$ ) times the width of the deck, including parapets and sidewalks, was applied as a uniform pressure over the vertical projection of the webs on the top flange cover. The tributary area was calculated as if the uplift force was a longitudinal line load at the windward quarter-point of the deck width.

- Dead and live loads from the tributary area on the deck were applied as a 13-mm (0.5-in.) wide uniform pressure over the vertical projection of the web on the top flange cover. These loads were applied over the vertical web projection on the top flange cover rather than over the entire flange cover to further prevent from occurring the model artifact of high-order buckling in the top flange.

## Stress Calculations

A free body cross section in Abaqus is an area of the model across which resultant forces and moments are computed. Once the cross section is defined, Abaqus can be used to output vectors that include the magnitude and direction of the resultant moments across the area that is selected. Major axis bending moments about the girder cross section were obtained using section cuts along Girder 3 (Figure 2). Girder 3 was chosen because the interior girders experienced higher moments than exterior girders. The girder cross section, which consists of the top flange, web, and bottom flange, is shown in Figure 6(a) along with the resultant moments.

Lateral flange bending moments were computed from both the top and bottom flanges individually using a procedure described in Jung and White (2006) as well as from the entire girder section. The top flange section cut is shown in Figure 6(b) along with the resultant lateral flange bending moment. Moment values were measured at locations where the cross frames connected to the web (where lateral flange bending stresses were expected to be at a maximum) and at the mid-point between two cross frame locations along the girder (where localized effects were expected to be least influential). Flexural stresses,  $\sigma$ , were calculated from these moments using the bending stress equation:

$$\sigma = Mc/I$$

**Equation 1**

Where:

M = flange or section bending moment

c = distance from the extreme fiber to the neutral axis

I = moment of inertia of the flange or section

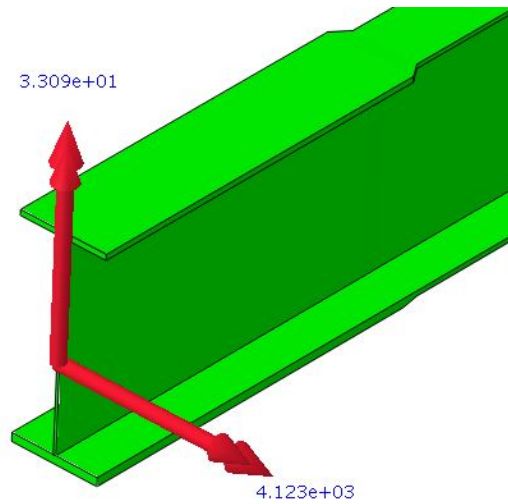

(a) Girder Section

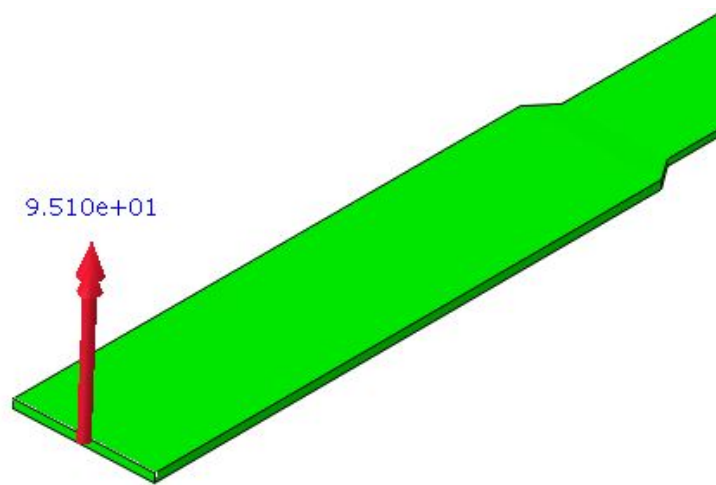

(b) Top Flange Section

**Figure 6: Resultant Moments Displayed on the Free Body Section**

The top flange had a  $c$  value of 152 mm (6 in.) and an  $I$  value of  $4.50 \times 10^{-5} \text{ m}^4$  (108 in.<sup>4</sup>) in the positive flexure region and a  $c$  value of 203 mm (8 in.) and an  $I$  value of  $1.42 \times 10^{-4} \text{ m}^4$  (341 in.<sup>4</sup>) in the negative flexure region. The bottom flange had a  $c$  value of 203 mm (8 in.) and an  $I$  value of  $1.24 \times 10^{-4} \text{ m}^4$  (108 in.<sup>4</sup>) in the positive flexure region, and a  $c$  value of 203 mm (8 in.) and an  $I$  value of  $2.13 \times 10^{-4} \text{ m}^4$  (341 in.<sup>4</sup>) in the negative flexure region. The  $c$  value for the

girder section was taken as 203 mm (8 in.) in weak axis bending for both the positive and negative flexure regions.

AASHTO (2010) presents interaction requirements combining minor-axis bending demands with major-axis demands based on factored loads:

$$f_{bu} + \frac{1}{3}f_l \leq \phi_f F_{nc} \quad \text{AASHTO (2010) 6.10.8.1.1-1} \quad \text{Equation 2}$$

Where:

$f_{bu}$  = major-axis demand (ksi)

$f_l$  = minor-axis demand (ksi)

$\phi_f$  = resistance factor for flexure, 1.0

$F_{nc}$  = nominal resistance factor, 50 ksi

In lieu of refined analysis, AASHTO (2010) permits engineers to use a minimum of  $f_l = 69$  MPa (10 ksi) for interior girders and  $f_l = 52$  MPa (7.5 ksi) for exterior girders. These values are based on a limited data set for skewed bridges. Therefore, it is important to further examine lateral flange bending stresses through refined analysis.

Load combinations and load factors are presented in AASHTO (2010) Section 3.4. The Strength load combinations and load factors from AASHTO Table 3.4.1-1 were found to produce the controlling load combination during the construction stage:

Strength 1 (S1): 1.25 DC + 1.25 DW + 1.75 LL

Strength 3 (S2): 1.25 DC + 1.25 DW + 1.4 WS (including uplift)

Strength 4 (S4): 1.50 DC + 1.50 DW

Strength 5 (S5): 1.25 DC + 1.25 DW + 1.35 LL + 0.4 WS (no uplift)

Where:

DC = dead load of structural components

DW = dead load of wearing surface

LL = construction live load

WS = wind load on structure

## Results

Tables 2 through 6 show the peak major axis bending stress, peak lateral flange bending stress, the AASHTO (2010) interaction equation result, and a calculated safety factor for five different bridge configurations. Safety factors were calculated based on a steel yield strength of 345 MPa (50 ksi). Maximum lateral flange bending stresses calculated from the top flange, bottom flange, and overall girder section are presented. Results from both the positive flexure region and negative flexure region of the bridge are shown.

From the results, Strength 1 produced the highest interaction equation results and lowest safety factors for all bridge configurations. The negative flexure region produced lower safety factors than the positive flexure region of the bridge. The highest lateral flange bending stresses were calculated based on moments obtained from the top flange in the positive moment region, while lateral flange bending stresses calculated from the bottom flange and girder section were generally much lower in that region. The negative flexure region produced much lower lateral flange bending stresses. The skewed-staggered and skewed-parallel configurations produced relatively similar interaction equation results. However, skewed-parallel configurations typically produced lower lateral flange bending stresses than skewed-staggered configurations.

The 40 degree skewed-staggered with 9.1-m (30-ft) cross frame spacing bridge configuration produced significantly higher lateral flange bending stresses in the top flange for the Strength 1 load combination than the 40 degree skewed-staggered with 4.6-m (15-ft) cross frame spacing bridge configuration. The highest lateral flange bending stress was found to be 243 MPa (35 ksi) in the top flange for Strength 1 in the 40 degree skewed-staggered with 9.14-m (30-ft) cross frame spacing bridge configuration.

AASHTO's interaction equation results were generally similar between 40 degree and 20 degree skewed configurations. However, Strength 1 lateral flange bending stress calculated from the top flange was significantly higher in the 40 degree skewed bridges. The 40 degree skewed-staggered bridge configuration produced a peak lateral flange bending stress of 176 MPa (25.5 ksi) compared to 126 MPa (18.3 ksi) for the 20 degree skewed-staggered bridge configuration. Similarly, the 40 degree skewed-parallel bridge configuration produced a peak

lateral flange bending stress of 155 MPa (22.5 ksi) compared to 155 MPa (13.3 ksi) for the 20 degree skewed-staggered bridge configuration.

The deformed shape of the 40 degree skewed-parallel with 4.57-m (15.0-ft) cross frame spacing bridge configuration is shown in Figure 7 for reference. Unfactored loads were applied, and wind loads were not considered since the controlling load combination was found to be Strength 1. The scale factor for displacement was set to 1. The stress contours shown in Figure 7 are Von Mises stresses, with the color map limits set between 0 and 345 MPa (50 ksi). High stress regions occurred in the flanges over the interior support.

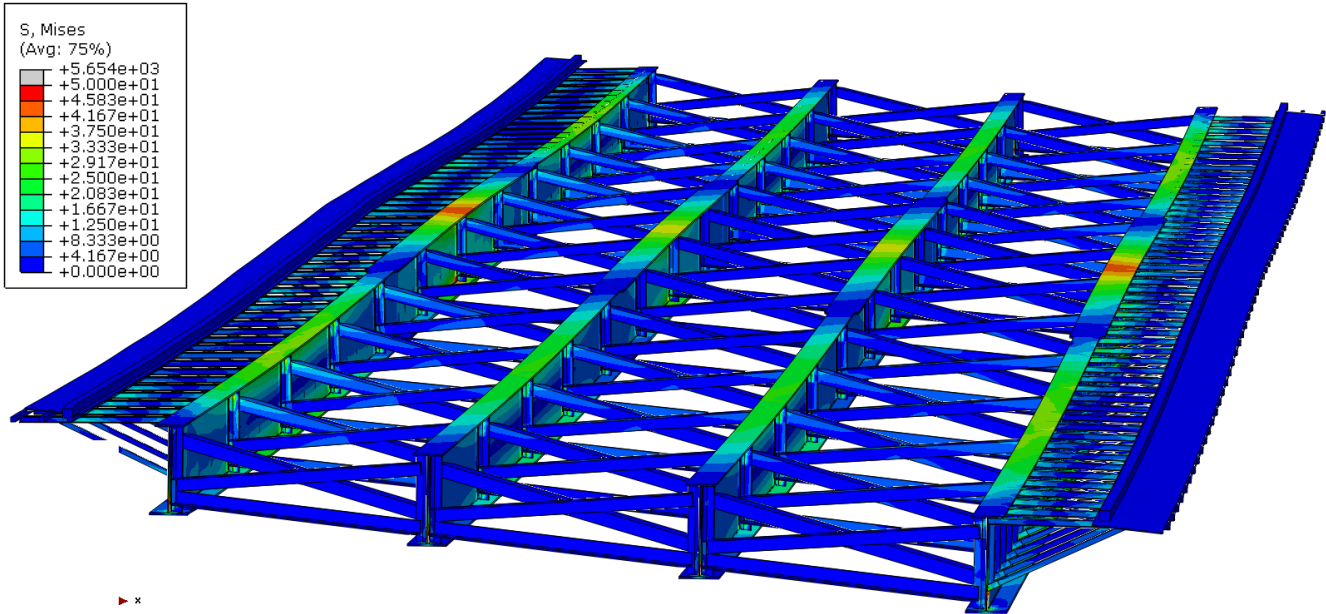

**Figure 7: Deformed Shape of the 40 Degree Skewed-Parallel with 4.57-m (15.0-ft) Cross Frame Spacing**

**Table 2: AASHTO Interaction Equation Results for 40 Degree Skewed-Staggered with 4.6-m (15-ft) Cross Frame Spacing**

Load Combination	$f_{bu}$ (MPa) [ksi]	$f_l$ (MPa) [ksi]	$\left[\frac{f_{bu} + f_l}{3}\right]$ (MPa) [ksi]	Safety Factor
Strength 1	195 [28.3]	176 [25.5]	254 [36.8]	1.36
Strength 3 (wind North)	90 [13.1]	55 [8.0]	109 [15.8]	3.17
Strength 3 (wind South)	67 [9.7]	35 [5.0]	78 [11.3]	4.41
Strength 4	123 [17.8]	39 [5.6]	136 [19.7]	2.54
Strength 5 (wind North)	171 [24.9]	103 [15.0]	206 [29.9]	1.67
Strength 5 (wind South)	171 [24.9]	99 [14.3]	204 [29.7]	1.69

*a) Top Flange – Positive Flexure Region*

Load Combination	$f_{bu}$ (MPa) [ksi]	$f_l$ (MPa) [ksi]	$\left[\frac{f_{bu} + f_l}{3}\right]$ (MPa) [ksi]	Safety Factor
Strength 1	225 [32.7]	93 [13.4]	256 [37.1]	1.35
Strength 3 (wind North)	107 [15.5]	22 [3.1]	114 [16.5]	3.03
Strength 3 (wind South)	78 [11.4]	26 [3.7]	87 [12.6]	3.96
Strength 4	145 [21.0]	11 [1.6]	148 [21.5]	2.32
Strength 5 (wind North)	196 [28.4]	52 [7.5]	213 [30.9]	1.62
Strength 5 (wind South)	195 [28.3]	45 [6.6]	210 [30.5]	1.64

*a) Top Flange – Negative Flexure Region*

Load Combination	$f_{bu}$ (MPa) [ksi]	$f_l$ (MPa) [ksi]	$\left[\frac{f_{bu} + f_l}{3}\right]$ (MPa) [ksi]	Safety Factor
Strength 1	195 [28.3]	80 [11.6]	222 [32.2]	1.55
Strength 3 (wind North)	90 [13.1]	29 [4.2]	100 [14.5]	3.45
Strength 3 (wind South)	67 [9.7]	27 [3.9]	76 [11.0]	4.56
Strength 4	123 [17.8]	23 [3.3]	130 [18.9]	2.64
Strength 5 (wind North)	171 [24.9]	41 [5.9]	185 [26.8]	1.86
Strength 5 (wind South)	171 [24.9]	44 [6.4]	186 [27.0]	1.85

*b) Bottom Flange – Positive Flexure Region*

Load Combination	$f_{bu}$ (MPa) [ksi]	$f_l$ (MPa) [ksi]	$\left[\frac{f_{bu} + f_l}{3}\right]$ (MPa) [ksi]	Safety Factor
Strength 1	225 [32.7]	77 [11.2]	251 [36.4]	1.37
Strength 3 (wind North)	107 [15.5]	9 [1.3]	110 [15.9]	3.14
Strength 3 (wind South)	78 [11.4]	15 [2.2]	83 [12.1]	4.13
Strength 4	145 [21.0]	10 [1.4]	148 [21.5]	2.33
Strength 5 (wind North)	196 [28.4]	48 [7.0]	212 [30.7]	1.63
Strength 5 (wind South)	195 [28.3]	47 [6.8]	211 [30.6]	1.63

*b) Bottom Flange – Negative Flexure Region*

Load Combination	$f_{bu}$ (MPa) [ksi]	$f_l$ (MPa) [ksi]	$\left[\frac{f_{bu} + f_l}{3}\right]$ (MPa) [ksi]	Safety Factor
Strength 1	195 [28.3]	37 [5.3]	207 [30.1]	1.66
Strength 3 (wind North)	90 [13.1]	12 [1.7]	94 [13.7]	3.66
Strength 3 (wind South)	67 [9.7]	23 [3.3]	74 [10.8]	4.65
Strength 4	123 [17.8]	8 [1.2]	125 [18.2]	2.75
Strength 5 (wind North)	171 [24.9]	25 [3.6]	180 [26.0]	1.92
Strength 5 (wind South)	171 [24.9]	21 [3.0]	178 [25.9]	1.93

*c) Girder Section – Positive Flexure Region*

Load Combination	$f_{bu}$ (MPa) [ksi]	$f_l$ (MPa) [ksi]	$\left[\frac{f_{bu} + f_l}{3}\right]$ (MPa) [ksi]	Safety Factor
Strength 1	225 [32.7]	18 [2.6]	231 [33.5]	1.49
Strength 3 (wind North)	107 [15.5]	6 [0.9]	109 [15.8]	3.17
Strength 3 (wind South)	78 [11.4]	17 [2.5]	84 [12.2]	4.10
Strength 4	145 [21.0]	3 [0.4]	146 [21.2]	2.36
Strength 5 (wind North)	196 [28.4]	12 [1.8]	200 [29.0]	1.73
Strength 5 (wind South)	195 [28.3]	11 [1.7]	199 [28.9]	1.73

*c) Girder Section – Negative Flexure Region*



**Table 3: AASHTO Interaction Equation Results for 40 Degree Skewed-Parallel with 4.6-m (15-ft) Cross Frame Spacing**

Load Combination	$f_{bu}$ (MPa) [ksi]	$f_l$ (MPa) [ksi]	$\left[\frac{f_{bu} + f_l}{3}\right]$ (MPa) [ksi]	Safety Factor
Strength 1	191 [27.7]	155 [22.5]	243 [35.2]	1.42
Strength 3 (wind North)	94 [13.6]	7 [1.1]	96 [14.0]	3.57
Strength 3 (wind South)	72 [10.5]	15 [2.2]	77 [11.2]	4.46
Strength 4	129 [18.8]	6 [0.8]	131 [19.0]	2.63
Strength 5 (wind North)	180 [26.1]	85 [12.4]	208 [30.2]	1.66
Strength 5 (wind South)	180 [26.2]	77 [11.2]	206 [29.9]	1.67

*a) Top Flange – Positive Flexure Region*

Load Combination	$f_{bu}$ (MPa) [ksi]	$f_l$ (MPa) [ksi]	$\left[\frac{f_{bu} + f_l}{3}\right]$ (MPa) [ksi]	Safety Factor
Strength 1	224 [32.5]	17 [2.4]	230 [33.3]	1.50
Strength 3 (wind North)	111 [16.2]	11 [1.6]	115 [16.7]	3.00
Strength 3 (wind South)	83 [12.1]	29 [4.2]	93 [13.5]	3.71
Strength 4	151 [21.9]	8 [1.2]	154 [22.3]	2.24
Strength 5 (wind North)	206 [29.8]	19 [2.8]	212 [30.7]	1.63
Strength 5 (wind South)	205 [29.7]	14 [2.0]	210 [30.4]	1.65

*a) Top Flange – Negative Flexure Region*

Load Combination	$f_{bu}$ (MPa) [ksi]	$f_l$ (MPa) [ksi]	$\left[\frac{f_{bu} + f_l}{3}\right]$ (MPa) [ksi]	Safety Factor
Strength 1	191 [27.7]	24 [3.5]	199 [28.9]	1.73
Strength 3 (wind North)	94 [13.6]	11 [1.5]	98 [14.2]	3.53
Strength 3 (wind South)	72 [10.5]	34 [5.0]	84 [12.1]	4.12
Strength 4	129 [18.8]	3 [0.4]	130 [18.9]	2.65
Strength 5 (wind North)	180 [26.1]	20 [2.9]	186 [27.0]	1.85
Strength 5 (wind South)	180 [26.2]	21 [3.0]	187 [27.2]	1.84

*b) Bottom Flange – Positive Flexure Region*

Load Combination	$f_{bu}$ (MPa) [ksi]	$f_l$ (MPa) [ksi]	$\left[\frac{f_{bu} + f_l}{3}\right]$ (MPa) [ksi]	Safety Factor
Strength 1	224 [32.5]	19 [2.8]	230 [33.4]	1.50
Strength 3 (wind North)	111 [16.2]	13 [1.9]	116 [16.8]	2.98
Strength 3 (wind South)	83 [12.1]	27 [3.9]	92 [13.4]	3.74
Strength 4	151 [21.9]	11 [1.6]	155 [22.5]	2.23
Strength 5 (wind North)	206 [29.8]	18 [2.6]	212 [30.7]	1.63
Strength 5 (wind South)	205 [29.7]	22 [3.2]	212 [30.8]	1.62

*b) Bottom Flange – Negative Flexure Region*

Load Combination	$f_{bu}$ (MPa) [ksi]	$f_l$ (MPa) [ksi]	$\left[\frac{f_{bu} + f_l}{3}\right]$ (MPa) [ksi]	Safety Factor
Strength 1	191 [27.7]	73 [10.6]	215 [31.2]	1.60
Strength 3 (wind North)	94 [13.6]	8 [1.2]	97 [14.0]	3.56
Strength 3 (wind South)	72 [10.5]	25 [3.7]	81 [11.7]	4.27
Strength 4	129 [18.8]	2 [0.3]	130 [18.9]	2.65
Strength 5 (wind North)	180 [26.1]	44 [6.4]	195 [28.2]	1.77
Strength 5 (wind South)	180 [26.2]	42 [6.1]	194 [28.2]	1.77

*c) Girder Section – Positive Flexure Region*

Load Combination	$f_{bu}$ (MPa) [ksi]	$f_l$ (MPa) [ksi]	$\left[\frac{f_{bu} + f_l}{3}\right]$ (MPa) [ksi]	Safety Factor
Strength 1	224 [32.5]	11 [1.7]	228 [33.0]	1.51
Strength 3 (wind North)	111 [16.2]	11 [1.6]	115 [16.7]	2.99
Strength 3 (wind South)	83 [12.1]	25 [3.6]	92 [13.3]	3.77
Strength 4	151 [21.9]	6 [0.9]	153 [22.2]	2.25
Strength 5 (wind North)	206 [29.8]	11 [1.6]	209 [30.3]	1.65
Strength 5 (wind South)	205 [29.7]	11 [1.7]	209 [30.3]	1.65

*c) Girder Section – Negative Flexure Region*

**Table 4: AASHTO Interaction Equation Results for 40 Degree Skewed-Staggered with 9.1-m (30-ft) Cross Frame Spacing**

Load Combination	$f_{bu}$ (MPa) [ksi]	$f_l$ (MPa) [ksi]	$\left[\frac{f_{bu} + f_l}{3}\right]$ (MPa) [ksi]	Safety Factor
Strength 1	168 [24.3]	243 [35.3]	249 [36.1]	1.39
Strength 3 (wind North)	100 [14.4]	68 [9.8]	122 [17.7]	2.82
Strength 3 (wind South)	58 [8.4]	52 [7.6]	75 [10.9]	4.60
Strength 4	126 [18.2]	22 [3.2]	133 [19.3]	2.59
Strength 5 (wind North)	158 [22.9]	115 [16.7]	197 [28.5]	1.75
Strength 5 (wind South)	158 [23.0]	100 [14.5]	191 [27.8]	1.80

*a) Top Flange – Positive Flexure Region*

Load Combination	$f_{bu}$ (MPa) [ksi]	$f_l$ (MPa) [ksi]	$\left[\frac{f_{bu} + f_l}{3}\right]$ (MPa) [ksi]	Safety Factor
Strength 1	207 [30.1]	80 [11.5]	234 [33.9]	1.48
Strength 3 (wind North)	116 [16.9]	40 [5.8]	130 [18.8]	2.66
Strength 3 (wind South)	68 [9.9]	31 [4.5]	78 [11.4]	4.39
Strength 4	147 [21.3]	3 [0.5]	148 [21.4]	2.33
Strength 5 (wind North)	184 [26.6]	33 [4.8]	195 [28.2]	1.77
Strength 5 (wind South)	183 [26.5]	26 [3.7]	191 [27.8]	1.80

*a) Top Flange – Negative Flexure Region*

Load Combination	$f_{bu}$ (MPa) [ksi]	$f_l$ (MPa) [ksi]	$\left[\frac{f_{bu} + f_l}{3}\right]$ (MPa) [ksi]	Safety Factor
Strength 1	168 [24.3]	110 [16.0]	205 [29.7]	1.69
Strength 3 (wind North)	100 [14.4]	32 [4.7]	110 [16.0]	3.13
Strength 3 (wind South)	58 [8.4]	45 [6.5]	73 [10.5]	4.75
Strength 4	126 [18.2]	24 [3.5]	134 [19.4]	2.58
Strength 5 (wind North)	158 [22.9]	45 [6.5]	173 [25.1]	1.99
Strength 5 (wind South)	158 [23.0]	54 [7.9]	176 [25.6]	1.95

*b) Bottom Flange – Positive Flexure Region*

Load Combination	$f_{bu}$ (MPa) [ksi]	$f_l$ (MPa) [ksi]	$\left[\frac{f_{bu} + f_l}{3}\right]$ (MPa) [ksi]	Safety Factor
Strength 1	207 [30.1]	47 [6.9]	223 [32.3]	1.55
Strength 3 (wind North)	116 [16.9]	19 [2.7]	123 [17.8]	2.81
Strength 3 (wind South)	68 [9.9]	25 [3.6]	76 [11.1]	4.52
Strength 4	147 [21.3]	7 [1.0]	149 [21.6]	2.32
Strength 5 (wind North)	184 [26.6]	22 [3.1]	191 [27.7]	1.81
Strength 5 (wind South)	183 [26.5]	25 [3.6]	191 [27.7]	1.80

*b) Bottom Flange – Negative Flexure Region*

Load Combination	$f_{bu}$ (MPa) [ksi]	$f_l$ (MPa) [ksi]	$\left[\frac{f_{bu} + f_l}{3}\right]$ (MPa) [ksi]	Safety Factor
Strength 1	168 [24.3]	124 [17.9]	209 [30.3]	1.65
Strength 3 (wind North)	100 [14.4]	38 [5.5]	112 [16.3]	3.07
Strength 3 (wind South)	58 [8.4]	31 [4.5]	68 [9.8]	5.08
Strength 4	126 [18.2]	14 [2.0]	130 [18.9]	2.65
Strength 5 (wind North)	158 [22.9]	52 [7.5]	175 [25.4]	1.97
Strength 5 (wind South)	158 [23.0]	40 [5.8]	172 [24.9]	2.01

*c) Girder Section – Positive Flexure Region*

Load Combination	$f_{bu}$ (MPa) [ksi]	$f_l$ (MPa) [ksi]	$\left[\frac{f_{bu} + f_l}{3}\right]$ (MPa) [ksi]	Safety Factor
Strength 1	207 [30.1]	21 [3.1]	214 [31.1]	1.61
Strength 3 (wind North)	116 [16.9]	25 [3.6]	125 [18.1]	2.77
Strength 3 (wind South)	68 [9.9]	23 [3.4]	76 [11.0]	4.55
Strength 4	147 [21.3]	4 [0.6]	148 [21.5]	2.33
Strength 5 (wind North)	184 [26.6]	10 [1.5]	187 [27.1]	1.84
Strength 5 (wind South)	183 [26.5]	8 [1.1]	185 [26.9]	1.86

*c) Girder Section – Negative Flexure Region*

**Table 5: AASHTO Interaction Equation Results for 20 Degree Skewed-Staggered with 4.6-m (15-ft) Cross Frame Spacing**

Load Combination	$f_{bu}$ (MPa) [ksi]	$f_i$ (MPa) [ksi]	$\left[\frac{f_{bu} + f_i}{3}\right]$ (MPa) [ksi]	Safety Factor
Strength 1	184 [26.8]	126 [18.3]	226 [32.8]	1.52
Strength 3 (wind North)	90 [13.1]	44 [6.3]	105 [15.2]	3.29
Strength 3 (wind South)	68 [9.8]	36 [5.2]	80 [11.6]	4.33
Strength 4	123 [17.9]	24 [3.4]	131 [19.0]	2.63
Strength 5 (wind North)	174 [25.3]	100 [14.5]	207 [30.1]	1.66
Strength 5 (wind South)	177 [25.7]	96 [14.0]	209 [30.4]	1.65

*a) Top Flange – Positive Flexure Region*

Load Combination	$f_{bu}$ (MPa) [ksi]	$f_i$ (MPa) [ksi]	$\left[\frac{f_{bu} + f_i}{3}\right]$ (MPa) [ksi]	Safety Factor
Strength 1	239 [34.6]	33 [4.8]	250 [36.2]	1.38
Strength 3 (wind North)	124 [17.9]	26 [3.8]	132 [19.2]	2.60
Strength 3 (wind South)	90 [13.1]	24 [3.5]	98 [14.3]	3.51
Strength 4	166 [24.1]	7 [1.1]	169 [24.5]	2.04
Strength 5 (wind North)	226 [32.8]	26 [3.8]	235 [34.1]	1.47
Strength 5 (wind South)	224 [32.6]	20 [3.0]	231 [33.5]	1.49

*a) Top Flange – Negative Flexure Region*

Load Combination	$f_{bu}$ (MPa) [ksi]	$f_i$ (MPa) [ksi]	$\left[\frac{f_{bu} + f_i}{3}\right]$ (MPa) [ksi]	Safety Factor
Strength 1	184 [26.8]	51 [7.4]	201 [29.2]	1.71
Strength 3 (wind North)	90 [13.1]	30 [4.3]	100 [14.5]	3.44
Strength 3 (wind South)	68 [9.8]	26 [3.7]	76 [11.1]	4.52
Strength 4	123 [17.9]	16 [2.3]	128 [18.6]	2.69
Strength 5 (wind North)	174 [25.3]	44 [6.4]	189 [27.4]	1.82
Strength 5 (wind South)	177 [25.7]	45 [6.5]	192 [27.9]	1.79

*b) Bottom Flange – Positive Flexure Region*

Load Combination	$f_{bu}$ (MPa) [ksi]	$f_i$ (MPa) [ksi]	$\left[\frac{f_{bu} + f_i}{3}\right]$ (MPa) [ksi]	Safety Factor
Strength 1	239 [34.6]	26 [3.7]	247 [35.9]	1.39
Strength 3 (wind North)	124 [17.9]	22 [3.2]	131 [19.0]	2.63
Strength 3 (wind South)	90 [13.1]	20 [2.9]	97 [14.1]	3.55
Strength 4	166 [24.1]	4 [0.6]	168 [24.3]	2.05
Strength 5 (wind North)	226 [32.8]	21 [3.0]	233 [33.8]	1.48
Strength 5 (wind South)	224 [32.6]	21 [3.1]	232 [33.6]	1.49

*b) Bottom Flange – Negative Flexure Region*

Load Combination	$f_{bu}$ (MPa) [ksi]	$f_i$ (MPa) [ksi]	$\left[\frac{f_{bu} + f_i}{3}\right]$ (MPa) [ksi]	Safety Factor
Strength 1	184 [26.8]	21 [3.0]	191 [27.7]	1.80
Strength 3 (wind North)	90 [13.1]	16 [2.3]	96 [13.9]	3.60
Strength 3 (wind South)	68 [9.8]	16 [2.4]	73 [10.6]	4.72
Strength 4	123 [17.9]	6 [0.8]	125 [18.1]	2.76
Strength 5 (wind North)	174 [25.3]	18 [2.6]	180 [26.1]	1.91
Strength 5 (wind South)	177 [25.7]	15 [2.1]	182 [26.4]	1.89

*c) Girder Section – Positive Flexure Region*

Load Combination	$f_{bu}$ (MPa) [ksi]	$f_i$ (MPa) [ksi]	$\left[\frac{f_{bu} + f_i}{3}\right]$ (MPa) [ksi]	Safety Factor
Strength 1	239 [34.6]	10 [1.4]	242 [35.1]	1.42
Strength 3 (wind North)	124 [17.9]	24 [3.4]	132 [19.1]	2.62
Strength 3 (wind South)	90 [13.1]	21 [3.1]	97 [14.1]	3.54
Strength 4	166 [24.1]	2 [0.3]	167 [24.2]	2.06
Strength 5 (wind North)	226 [32.8]	9 [1.4]	230 [33.3]	1.50
Strength 5 (wind South)	224 [32.6]	9 [1.3]	227 [33.0]	1.52

*c) Girder Section – Negative Flexure Region*

**Table 6: AASHTO Interaction Equation Results for 20 Degree Skewed-Parallel with 4.6-m (15-ft) Cross Frame Spacing**

Load Combination	$f_{bu}$ (MPa) [ksi]	$f_l$ (MPa) [ksi]	$\left[\frac{f_{bu} + f_l}{3}\right]$ (MPa) [ksi]	Safety Factor
Strength 1	208 [30.2]	92 [13.3]	239 [34.6]	1.45
Strength 3 (wind North)	90 [13.0]	15 [2.2]	95 [13.8]	3.63
Strength 3 (wind South)	71 [10.3]	14 [2.1]	76 [11.0]	4.55
Strength 4	124 [18.0]	4 [0.6]	125 [18.2]	2.75
Strength 5 (wind North)	82 [11.9]	31 [4.5]	92 [13.4]	3.73
Strength 5 (wind South)	181 [26.2]	25 [3.6]	189 [27.4]	1.83

*a) Top Flange – Positive Flexure Region*

Load Combination	$f_{bu}$ (MPa) [ksi]	$f_l$ (MPa) [ksi]	$\left[\frac{f_{bu} + f_l}{3}\right]$ (MPa) [ksi]	Safety Factor
Strength 1	264 [38.3]	13 [1.9]	269 [39.0]	1.28
Strength 3 (wind North)	123 [17.9]	30 [4.4]	133 [19.3]	2.59
Strength 3 (wind South)	94 [13.7]	30 [4.3]	104 [15.1]	3.31
Strength 4	167 [24.3]	4 [0.5]	168 [24.4]	2.05
Strength 5 (wind North)	80 [11.7]	16 [2.3]	86 [12.4]	4.03
Strength 5 (wind South)	234 [33.9]	11 [1.6]	238 [34.5]	1.45

*a) Top Flange – Negative Flexure Region*

Load Combination	$f_{bu}$ (MPa) [ksi]	$f_l$ (MPa) [ksi]	$\left[\frac{f_{bu} + f_l}{3}\right]$ (MPa) [ksi]	Safety Factor
Strength 1	208 [30.2]	16 [2.3]	213 [30.9]	1.62
Strength 3 (wind North)	90 [13.0]	26 [3.7]	98 [14.3]	3.51
Strength 3 (wind South)	71 [10.3]	26 [3.8]	80 [11.6]	4.33
Strength 4	124 [18.0]	2 [0.2]	124 [18.0]	2.77
Strength 5 (wind North)	82 [11.9]	9 [1.3]	85 [12.3]	4.05
Strength 5 (wind South)	181 [26.2]	11 [1.7]	184 [26.7]	1.87

*b) Bottom Flange – Positive Flexure Region*

Load Combination	$f_{bu}$ (MPa) [ksi]	$f_l$ (MPa) [ksi]	$\left[\frac{f_{bu} + f_l}{3}\right]$ (MPa) [ksi]	Safety Factor
Strength 1	264 [38.3]	15 [2.1]	269 [39.0]	1.28
Strength 3 (wind North)	123 [17.9]	28 [4.1]	132 [19.2]	2.60
Strength 3 (wind South)	94 [13.7]	28 [4.1]	104 [15.0]	3.33
Strength 4	167 [24.3]	6 [0.9]	169 [24.6]	2.04
Strength 5 (wind North)	80 [11.7]	15 [2.2]	85 [12.4]	4.03
Strength 5 (wind South)	234 [33.9]	19 [2.7]	240 [34.9]	1.43

*b) Bottom Flange – Negative Flexure Region*

Load Combination	$f_{bu}$ (MPa) [ksi]	$f_l$ (MPa) [ksi]	$\left[\frac{f_{bu} + f_l}{3}\right]$ (MPa) [ksi]	Safety Factor
Strength 1	208 [30.2]	43 [6.3]	222 [32.3]	1.55
Strength 3 (wind North)	90 [13.0]	19 [2.7]	96 [13.9]	3.59
Strength 3 (wind South)	71 [10.3]	19 [2.8]	77 [11.2]	4.45
Strength 4	124 [18.0]	2 [0.2]	124 [18.0]	2.77
Strength 5 (wind North)	82 [11.9]	6 [0.9]	84 [12.2]	4.09
Strength 5 (wind South)	181 [26.2]	16 [2.3]	186 [26.9]	1.86

*c) Girder Section – Positive Flexure Region*

Load Combination	$f_{bu}$ (MPa) [ksi]	$f_l$ (MPa) [ksi]	$\left[\frac{f_{bu} + f_l}{3}\right]$ (MPa) [ksi]	Safety Factor
Strength 1	264 [38.3]	9 [1.3]	267 [38.8]	1.29
Strength 3 (wind North)	123 [17.9]	27 [4.0]	132 [19.2]	2.61
Strength 3 (wind South)	94 [13.7]	27 [4.0]	103 [15.0]	3.33
Strength 4	167 [24.3]	4 [0.5]	168 [24.4]	2.05
Strength 5 (wind North)	80 [11.7]	9 [1.3]	83 [12.1]	4.13
Strength 5 (wind South)	234 [33.9]	12 [1.7]	238 [34.5]	1.45

*c) Girder Section – Negative Flexure Region*

## Conclusions

The results of a study aimed at investigating the effect of skew angle and cross frame layout on lateral flange bending stresses in skewed steel bridges showed that:

- The highest lateral flange bending stresses, produced by the Strength 1 load combination, were found to occur in the top flange of the positive flexure region of the skewed-staggered bridge.
- Maximum lateral flange bending stresses were significantly lower in bridges that utilized cross frames placed parallel to the angle of skew than for cases in which cross frames were placed perpendicular to the girder line and staggered.
- Reducing the skew angle decreased lateral flange bending stresses under certain load cases where these stresses were significant.
- Decreasing cross-frame spacing provided more brace support and helped reduce lateral flange bending stresses.
- The values of maximum lateral flange bending stress for the controlling load case of all configurations were greater than the values suggested by AASHTO (2010), by as much as a factor of 3.5.

Although the results did not invalidate AASHTO's interaction equation requirements, the minimum safety factor computed was only 28 percent. Lateral flange bending stresses were found to have higher nominal values than major axis bending stresses for 40 degree skewed bridges with 4.6-m (15-ft) cross frame spacing. Overall, lateral flange bending stresses were found to be significantly higher than the minimum values prescribed in the AASHTO (2010) *LRFD Bridge Design Specifications*. In the future, this study should be expanded to include other bridge geometries to further investigate this phenomenon.

## References

- Abaqus FEA (Version 6.10) [Computer software]. (2010). <http://www.simulia.com>
- American Association of State Highway and Transportation Officials (AASHTO). (2010). *AASHTO LRFD bridge design specifications* (5th ed.). Washington, DC: Author.
- American Institute of Steel Construction (AISC). (2010). *Steel construction manual* (14th ed.). Chicago, IL: Author.
- HDR Engineering, Inc. (1999). Design example 2: Two-span continuous composite I girder. In *Four LRFD design examples of steel highway bridges* (pp. 2-1 – 2-64). National Steel Bridge Alliance.
- Jung, S.K., & White, D.W. (2006). Shear strength of horizontally curved steel I-girders — Finite element analysis studies. *Journal of Constructional Steel Research*, 62(4), 329-342.
- Kansas Department of Transportation (KDOT). (2010). *Design manual, volume III: Bridge section*. Topeka, KS: Author.
- Wang, L., & Helwig, T.A. (2008). Stability bracing requirements for steel bridge girders with skewed supports. *Journal of Bridge Engineering*, 13(2), 149-157.
- Yura, J.A. (2001). Fundamentals of beam bracing. *Engineering Journal*, 38(1), 11-26.



# K-TRAN

## KANSAS TRANSPORTATION RESEARCH AND NEW-DEVELOPMENT PROGRAM

